

eduard
MASK

EX 186

He 177 Greif 1/48

The die-cut mask for accurate canopy frame painting of the
MPM
scale 1/48 KIT

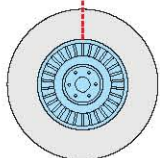
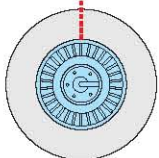
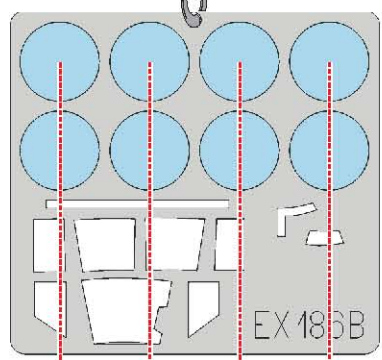
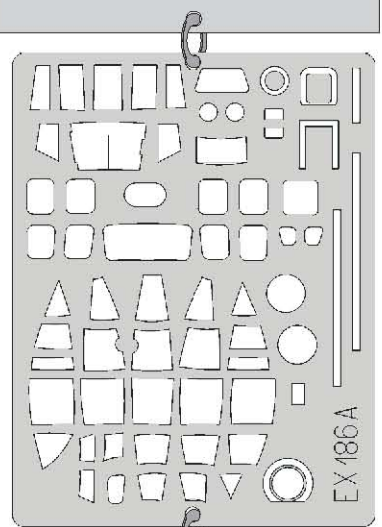

4pcs J1

4pcs J2

1.) CP6+D18

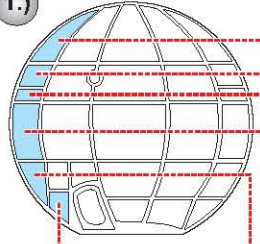

2.) CP6+D18

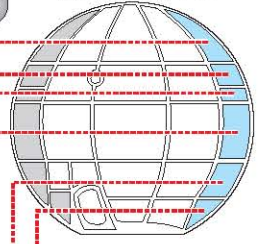

3.)

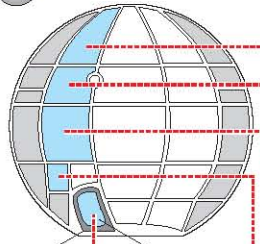

D18

CP

4.)

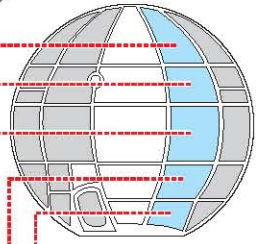

5.)

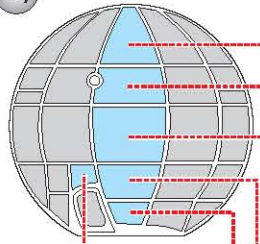

1.)

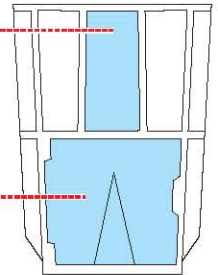

CP10

3.)

2.)

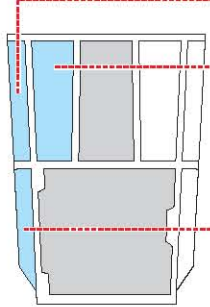

CP10

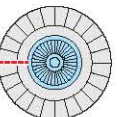
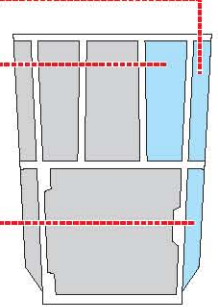

E7, E8

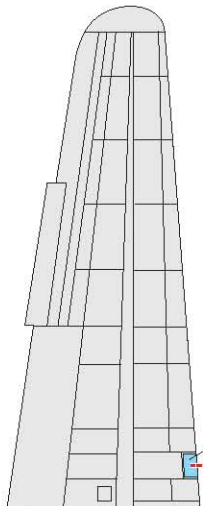

CP15

1.)

CP5

2.)

CP4

CP3

CP19

3.)

CP9

4.)

CP5

CP16

LIQUID MASK

CP1

CP12

CP11

CP13

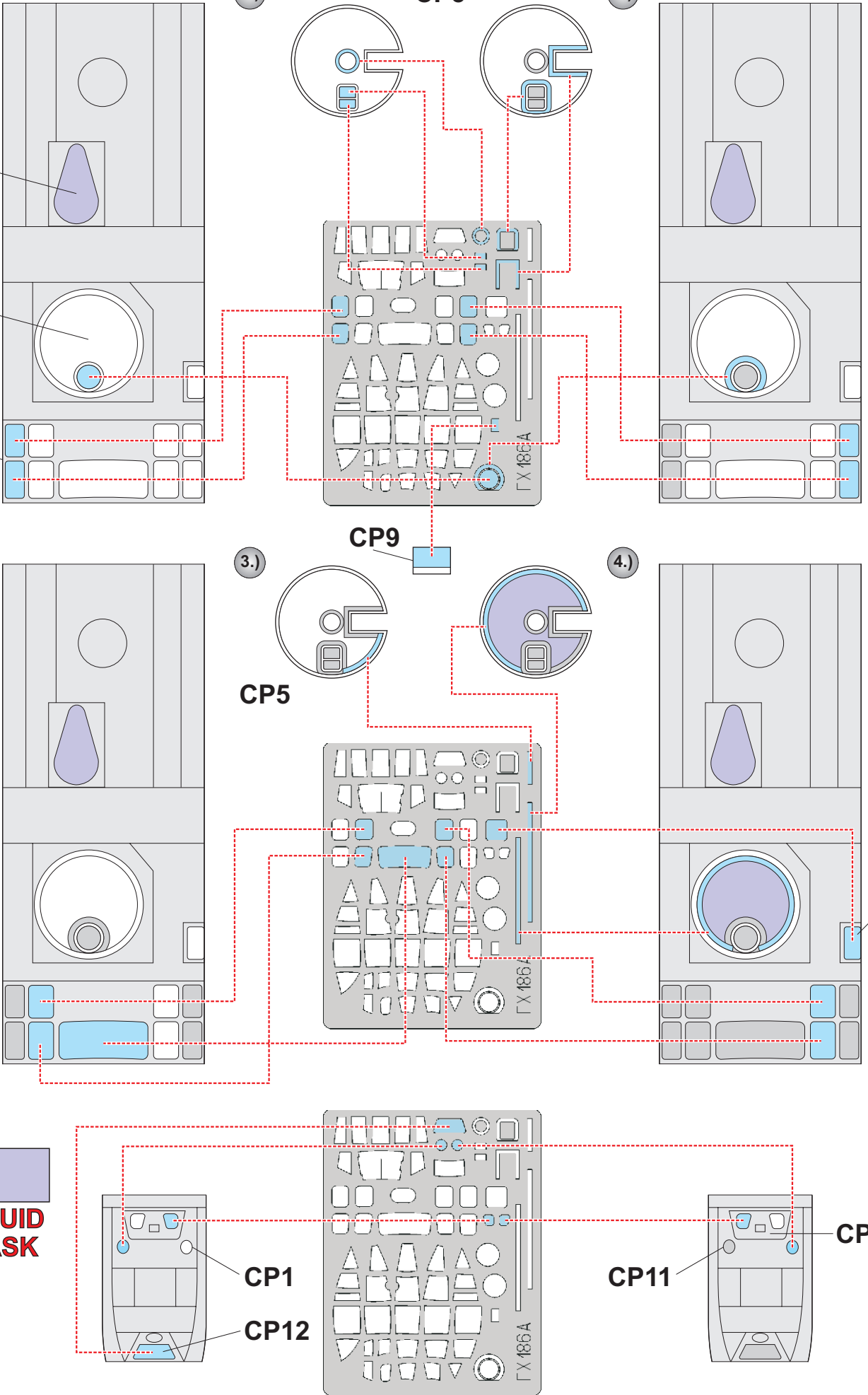

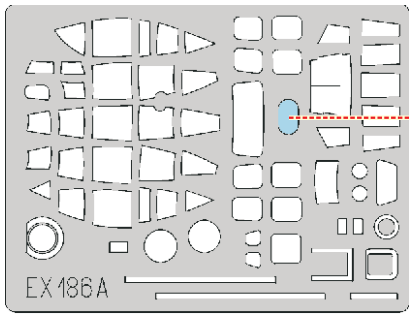

CP14

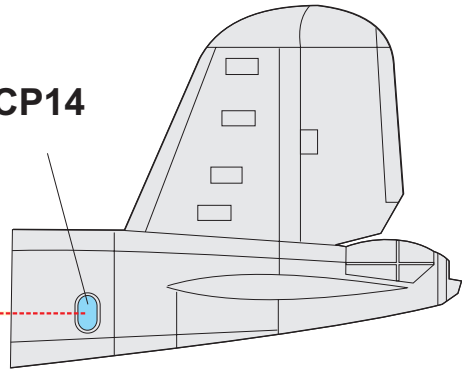

1.)

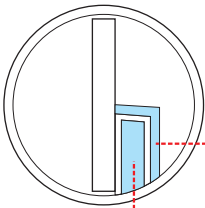

CP18

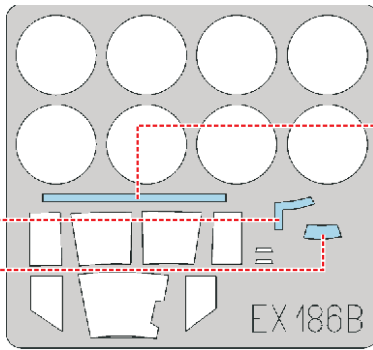

2.)

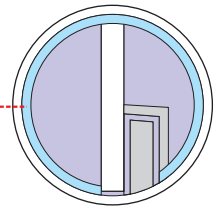

1.)

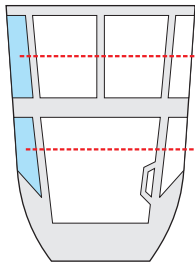

CP17

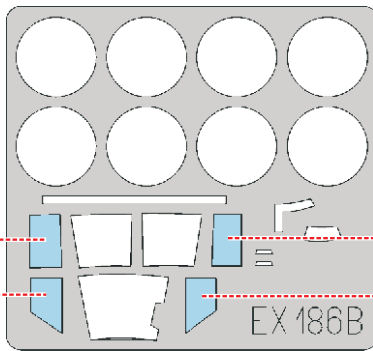

2.)

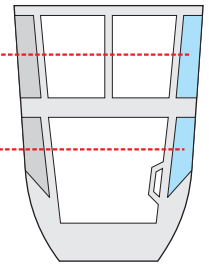

3.)

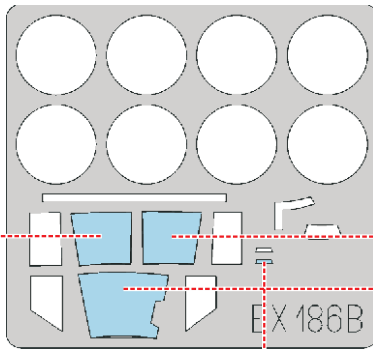
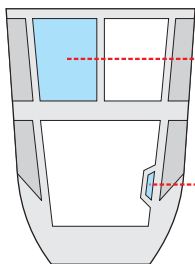

4.)

